

HONDA CB300R '18

REF 9757N

PROTECTOR MOTOR PARA / CRASH PADS FOR / STURZPADS FÜR

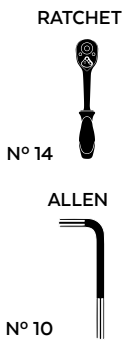
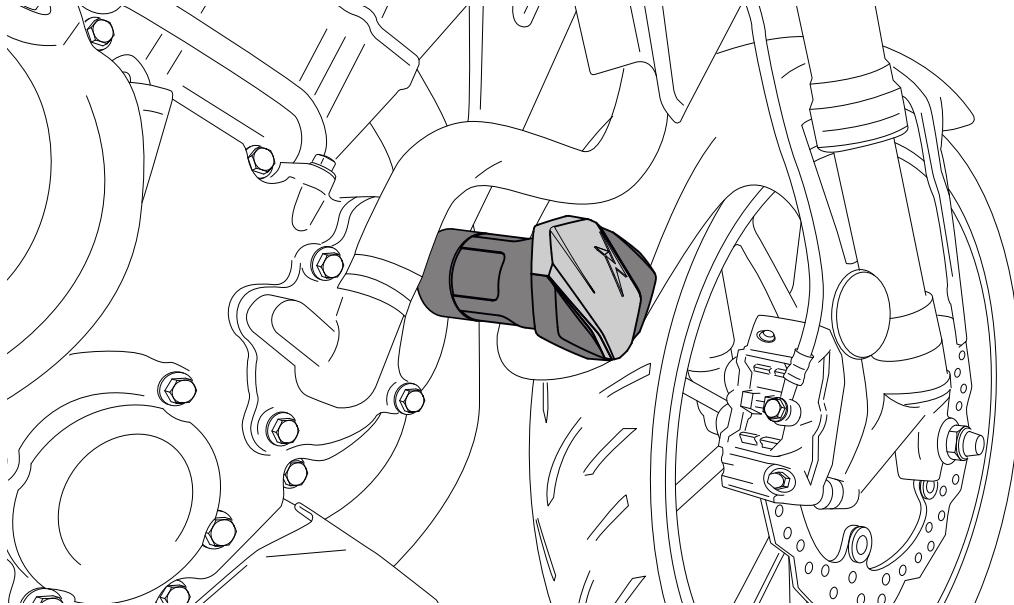

ID.	PIEZA / PART	DESCRIPCIÓN	DESCRIPTION	QTY.	REF.:
1		Tapón de plástico	Plastic cap	2	CONGOMANPRO-R12
2		Tornillo M10/150x25 DIN912	M10/150x25 DIN912 screw	2	TORNIAD912--419
3		Arandela M10 DIN125/A	M10 DIN125/A washer	2	M2AM10DIN125AZB
4		Protector Nylon 85mm	Nylon protector 85mm	2	PROTECNLR12-145
5		Casquillo aluminio	Right aluminium metal spacer	2	CASQU399-0-1699
6		Varilla 205mm	Bar 205mm	1	VARILL31-0-0031

HONDA CB300R '18

INSTRUCCIONES DE MONTAJE - MOUNTING INSTRUCTIONS - MONTAGEANLEITUNG

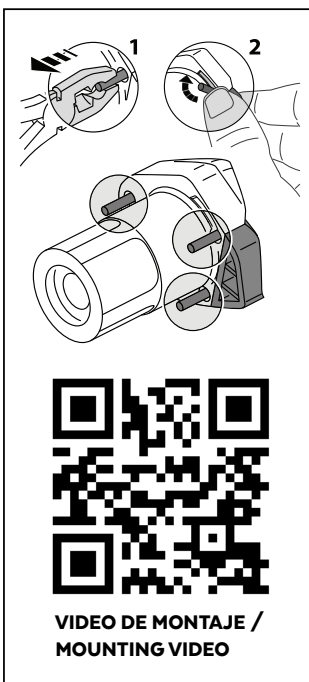
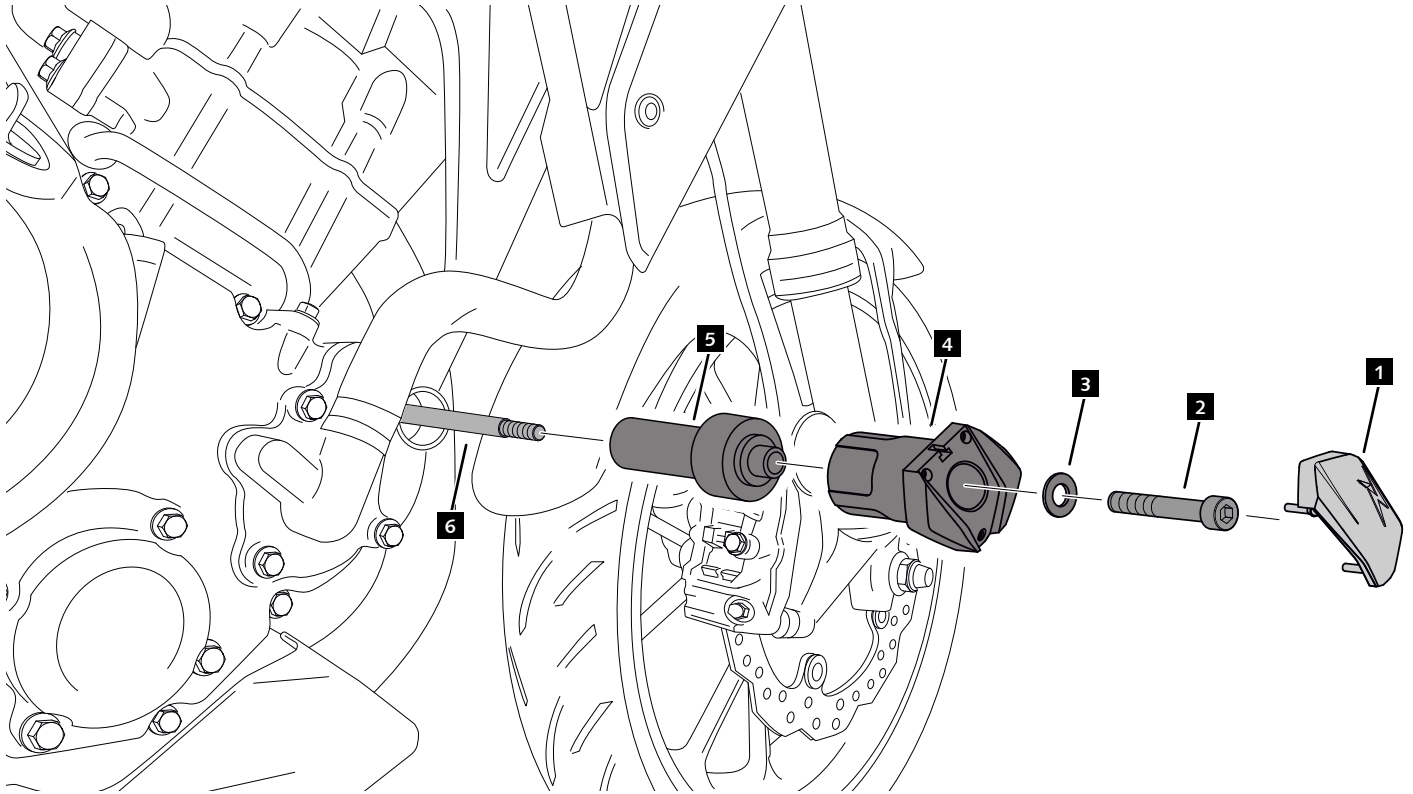

**CONSULTAR EN NUESTRA PAGINA WEB LA DISPONIBILIDAD DEL VIDEO DE MONTAJE DE ESTA REFERENCIA.
CONSULT OUR WEBSITE THE VIDEO MOUNT AVAILABILITY OF THIS REFERENCE.**

